

LEGENDA:

Esquadrias

J1 - Janela e porta vedadas a 200cm, de unidade
P2 - Porta vedada a 200cm, de unidade
P2 - J1 - 200cm - medidas em 0,00 milímetros
ESCALA 1:25

Relação de revestimentos

- 1 Acost. Colarimetar. Alcatraz - espessura de 2cm e junta de 2cm no ar-grande
- 2 Piso em concreto armado
- 3 Paredes em alvenaria

REVESTIMENTOS

- 1 Revestimento: Cerâmica Porcelanato (area) - 30x30cm com junta de 2mm
- 2 Paredes: Alvenaria Fígula Branca Modelo Fígula
- 3 Teto: Teto de concreto armado

MOBILIÁRIO

Balões e pias em MDF (60x60) sem apoio. Desenhado por...



J1 - Janela e porta vedadas a 200cm, de unidade
P2 - Porta vedada a 200cm, de unidade
P2 - J1 - 200cm - medidas em 0,00 milímetros
ESCALA 1:25

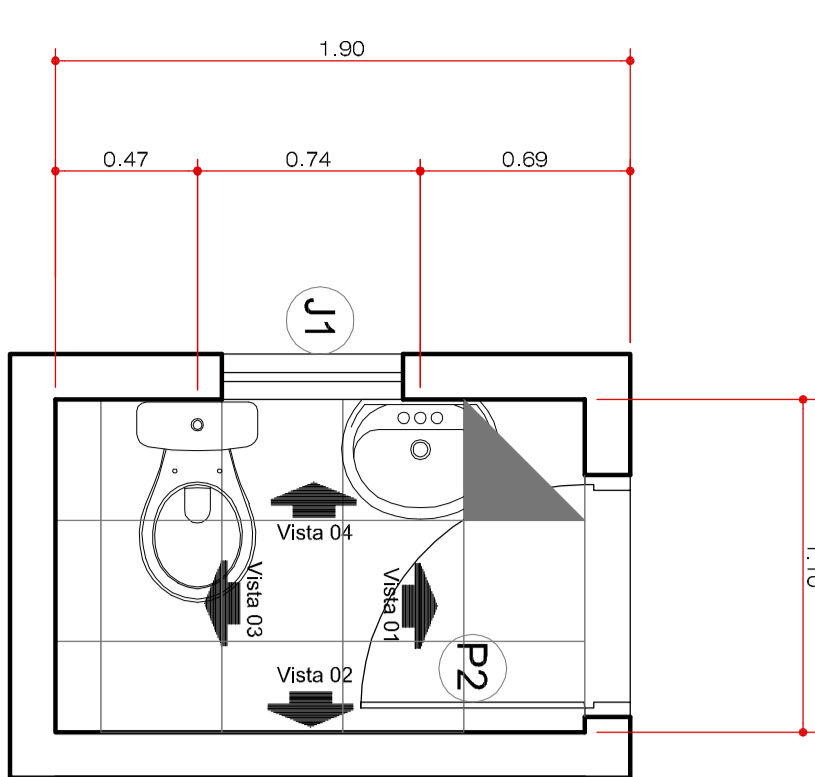
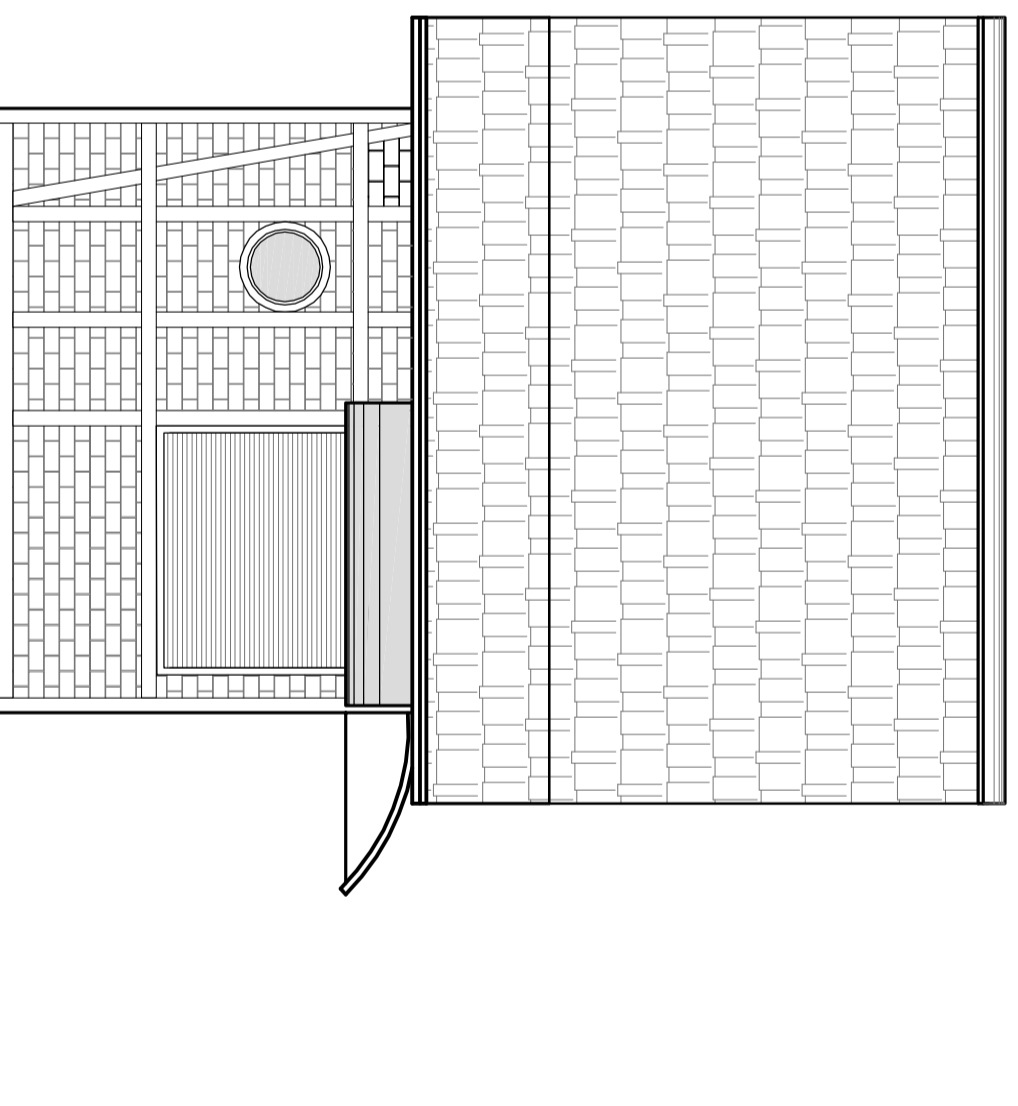
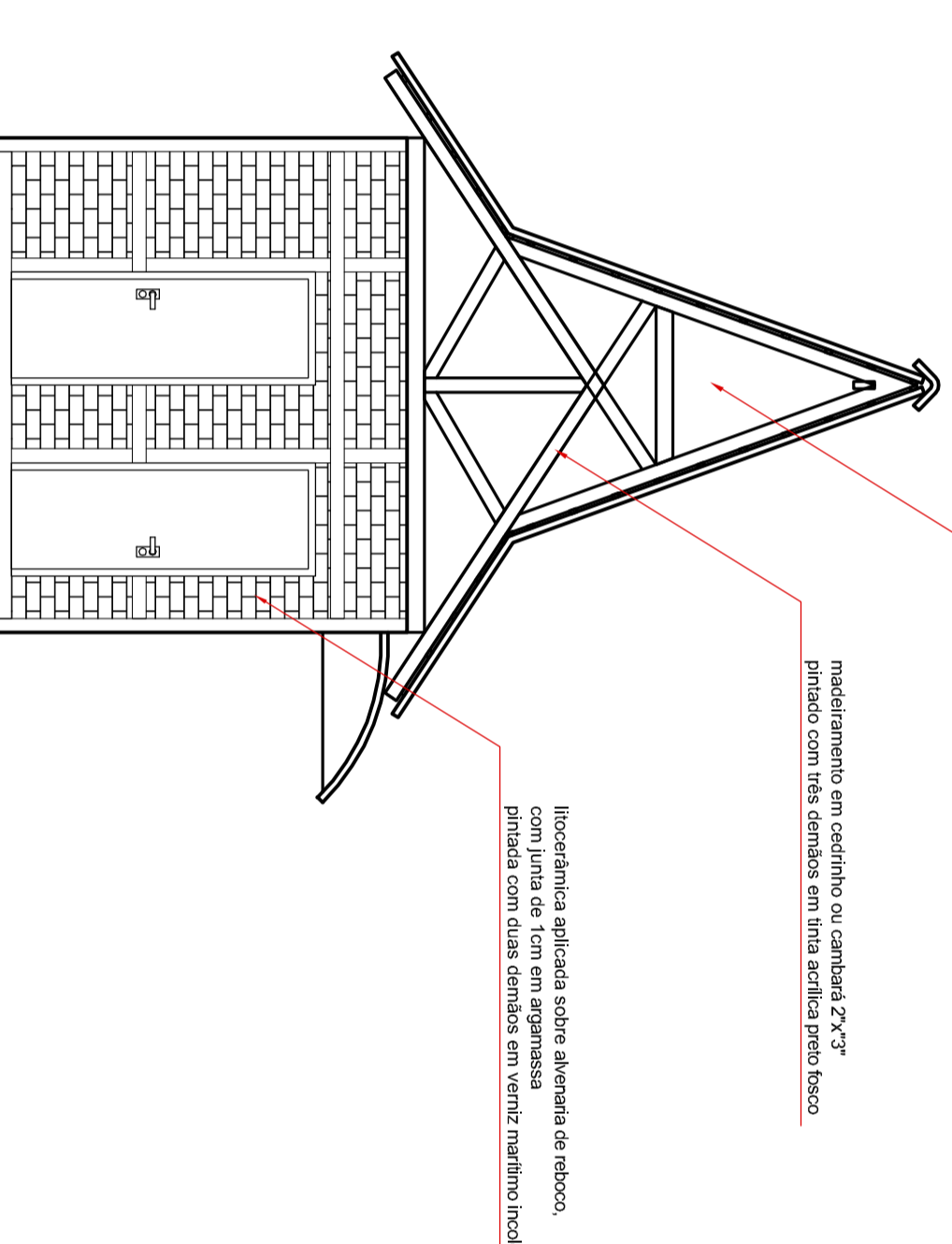
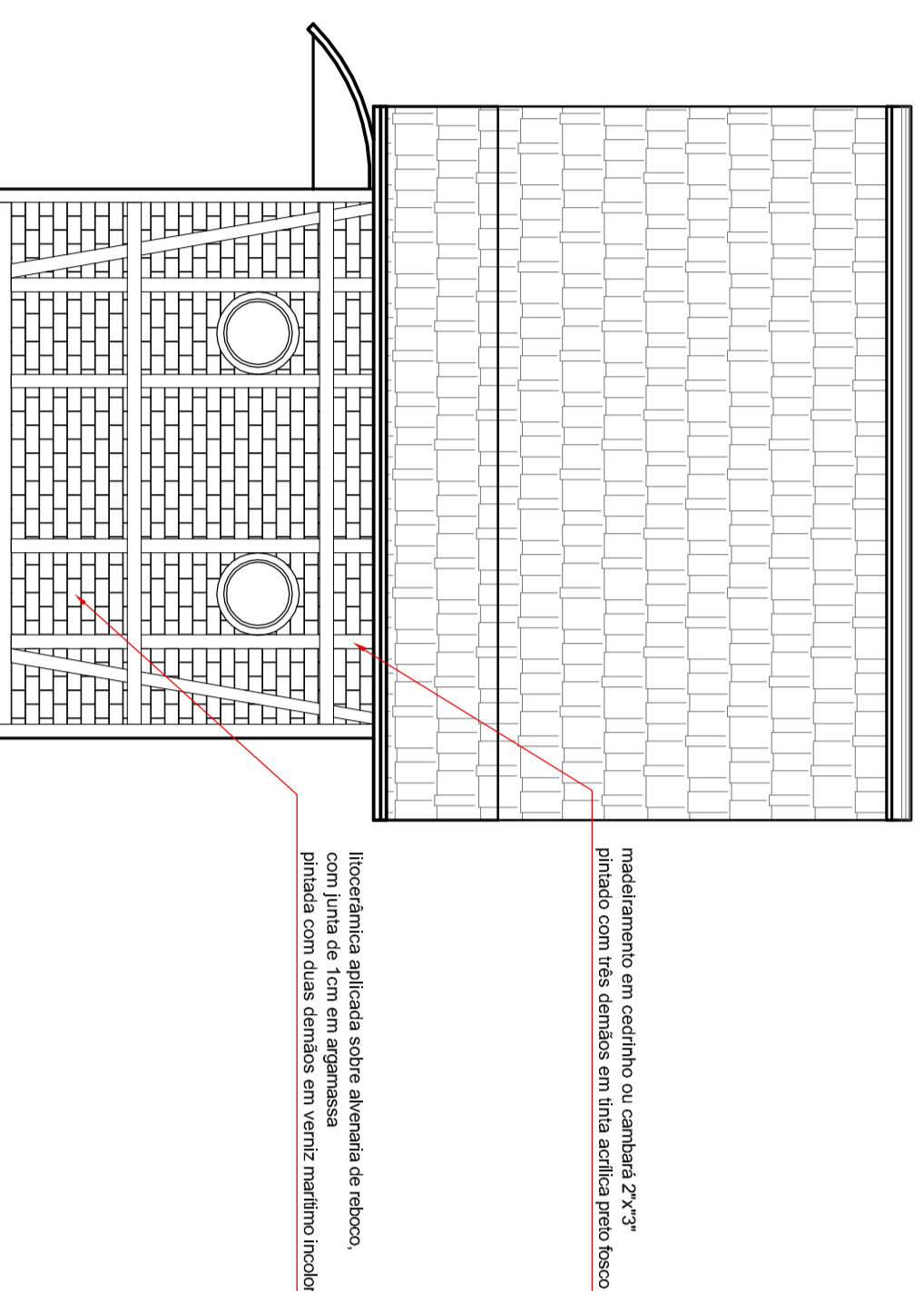
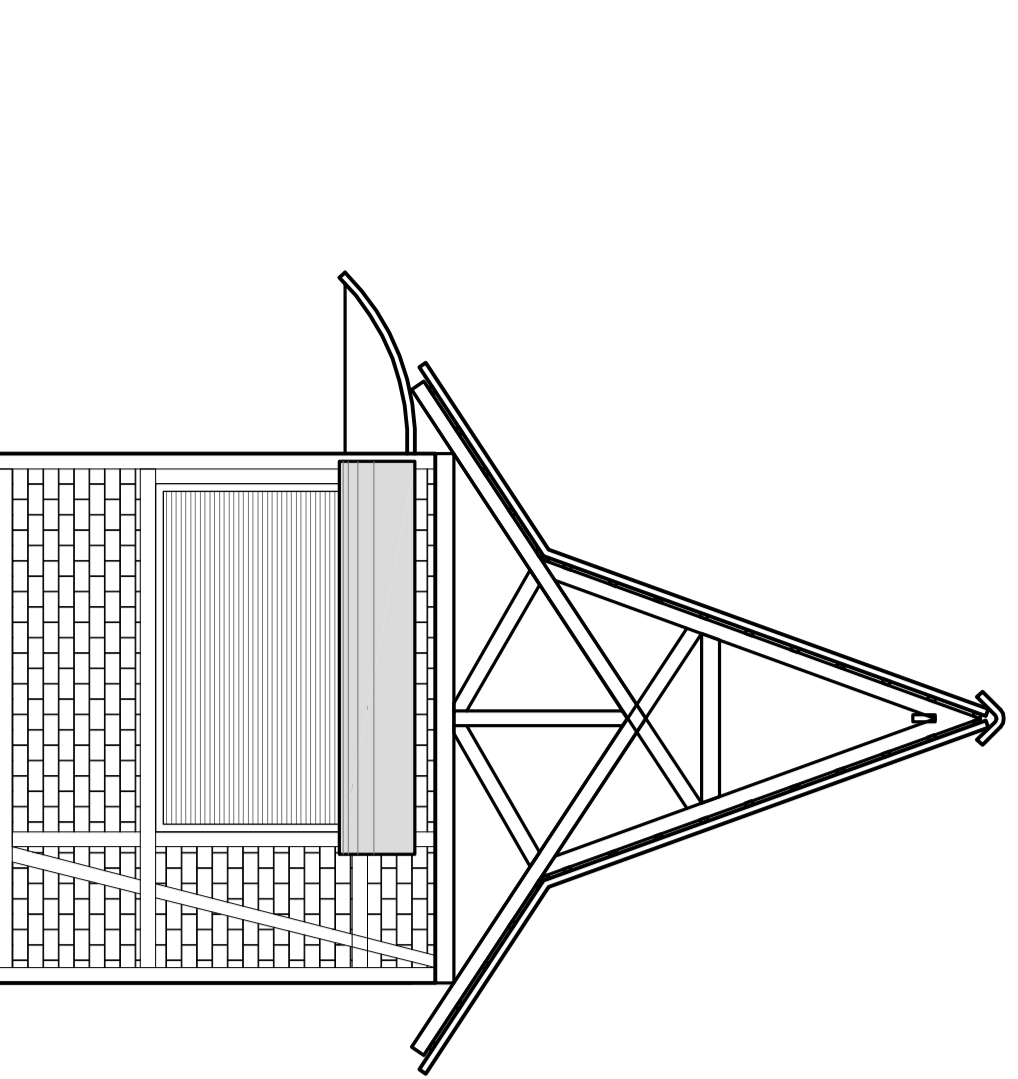
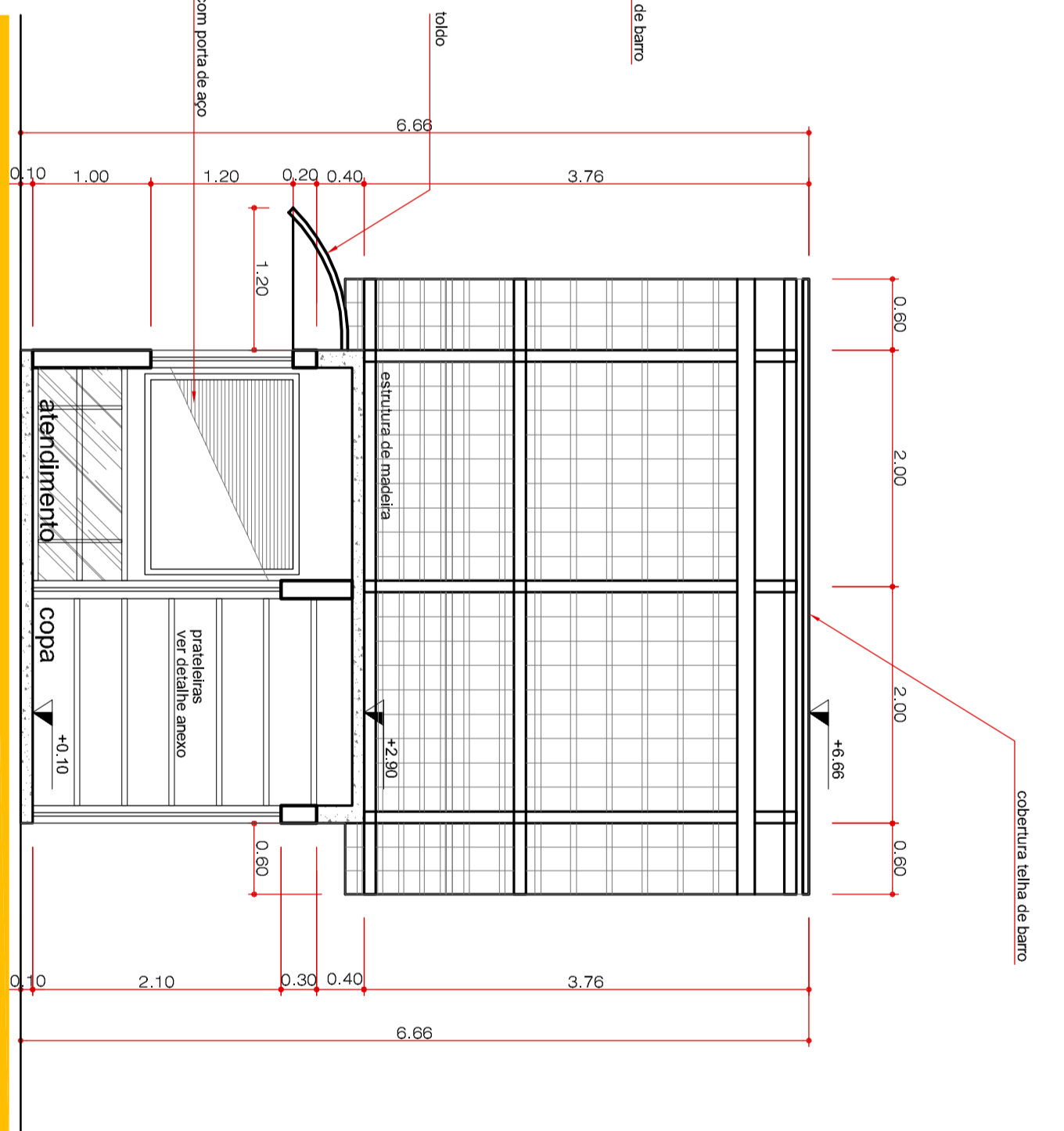
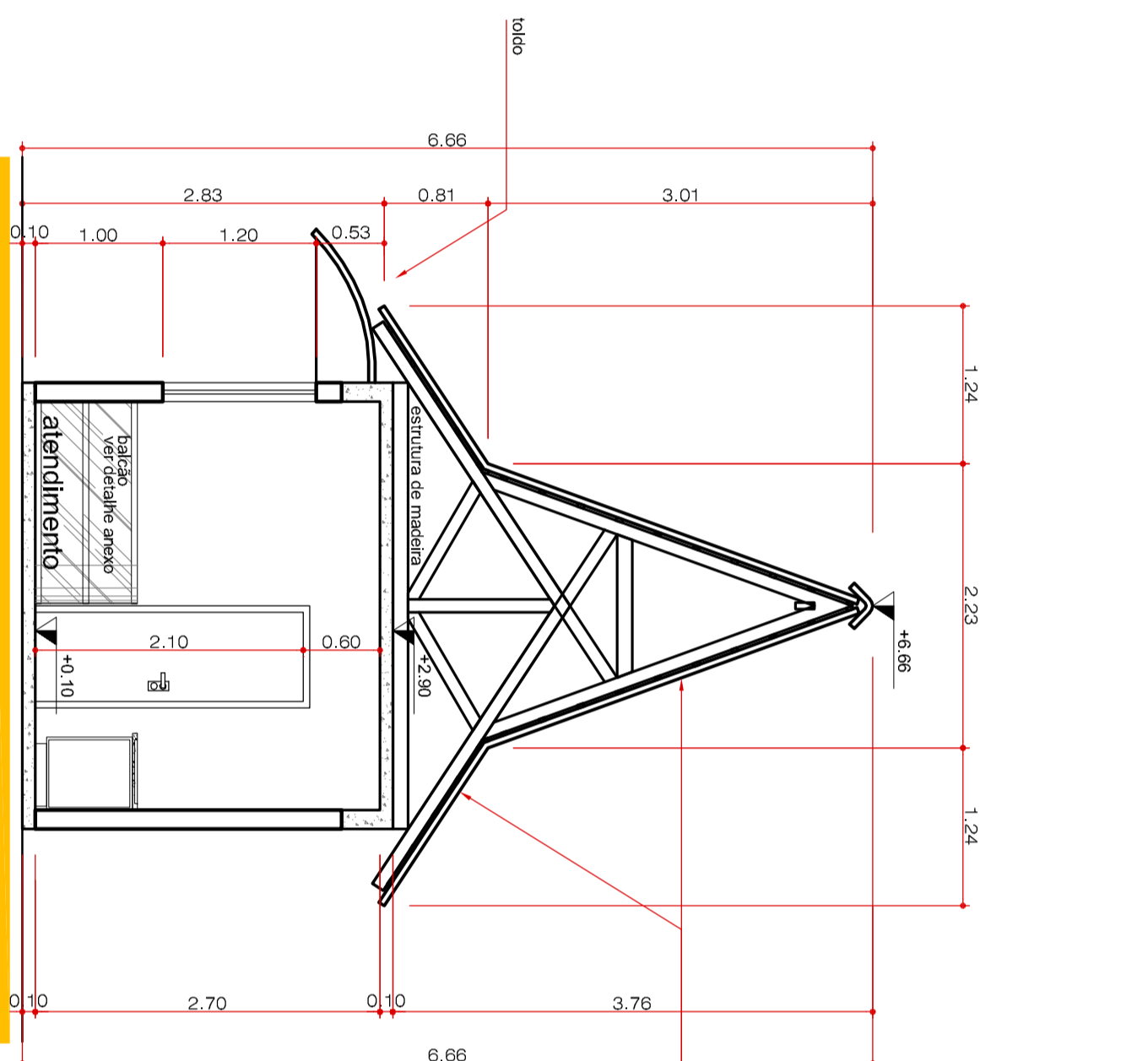
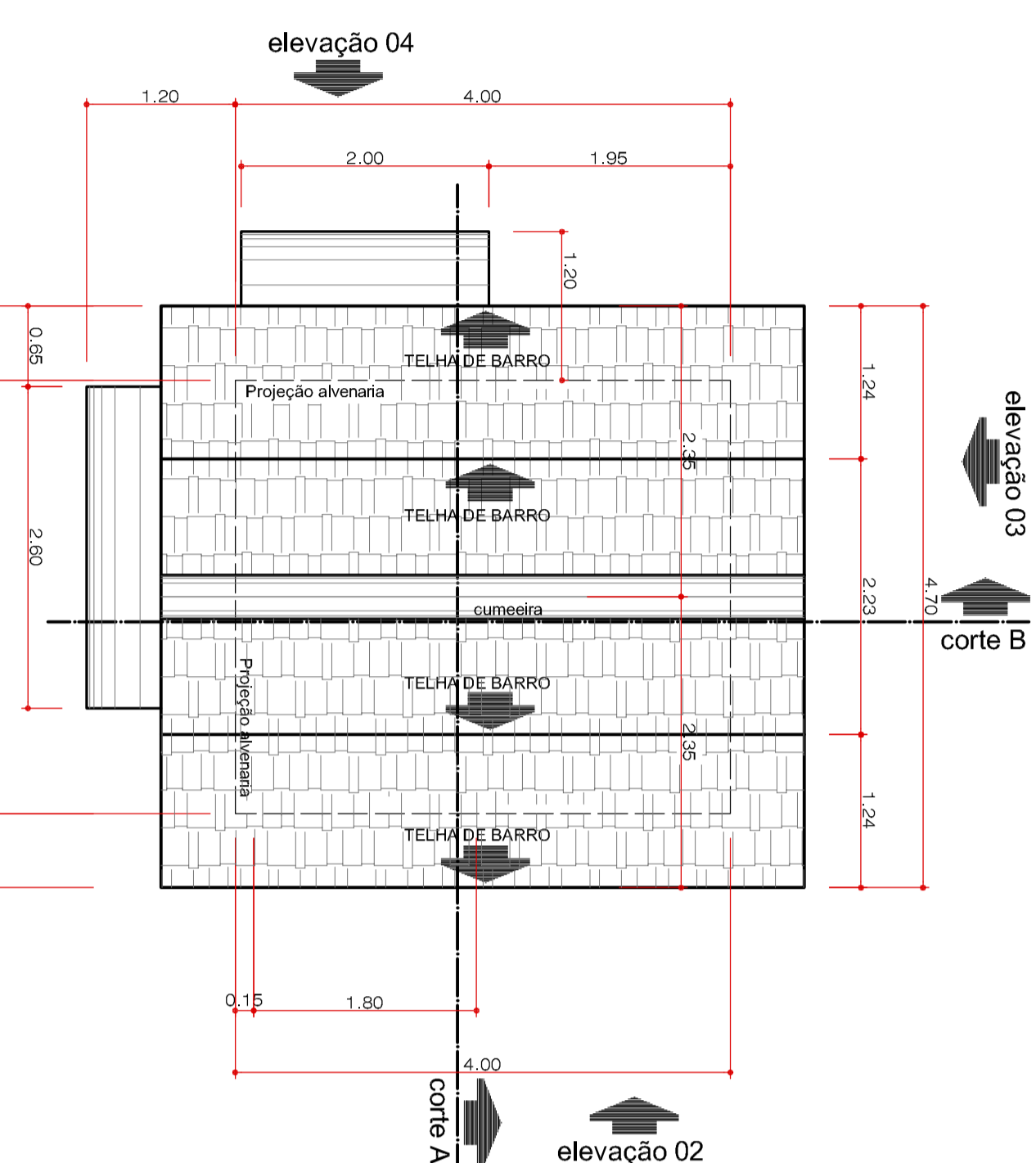
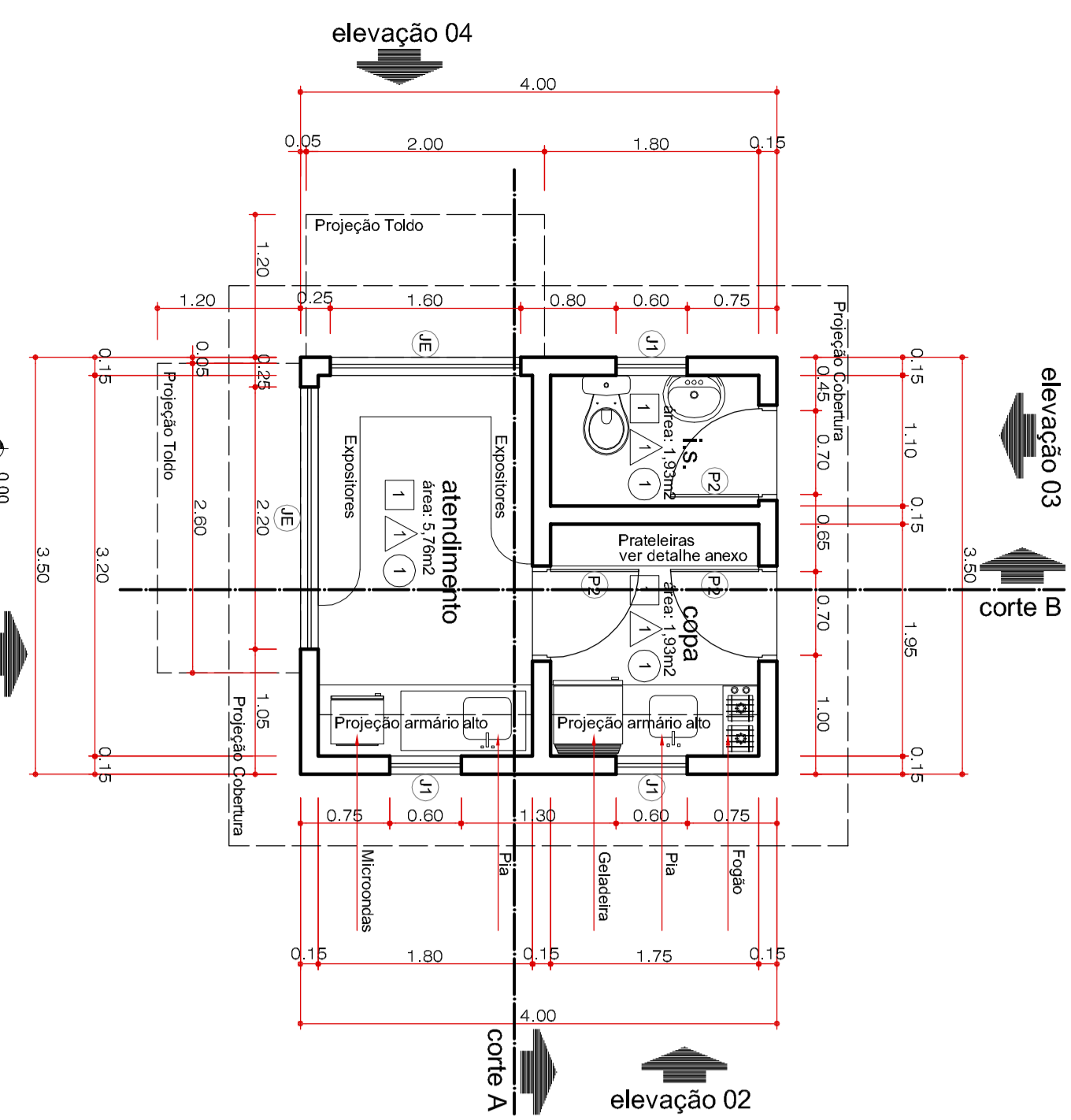

Detalhamento do i.s.

- 1 Alvenaria estrutural em bloco de concreto ou alvenaria 2x4"
- 2 Acost. Colarimetar. Alcatraz - espessura de 2cm e junta de 2cm no ar-grande
- 3 Paredes em alvenaria

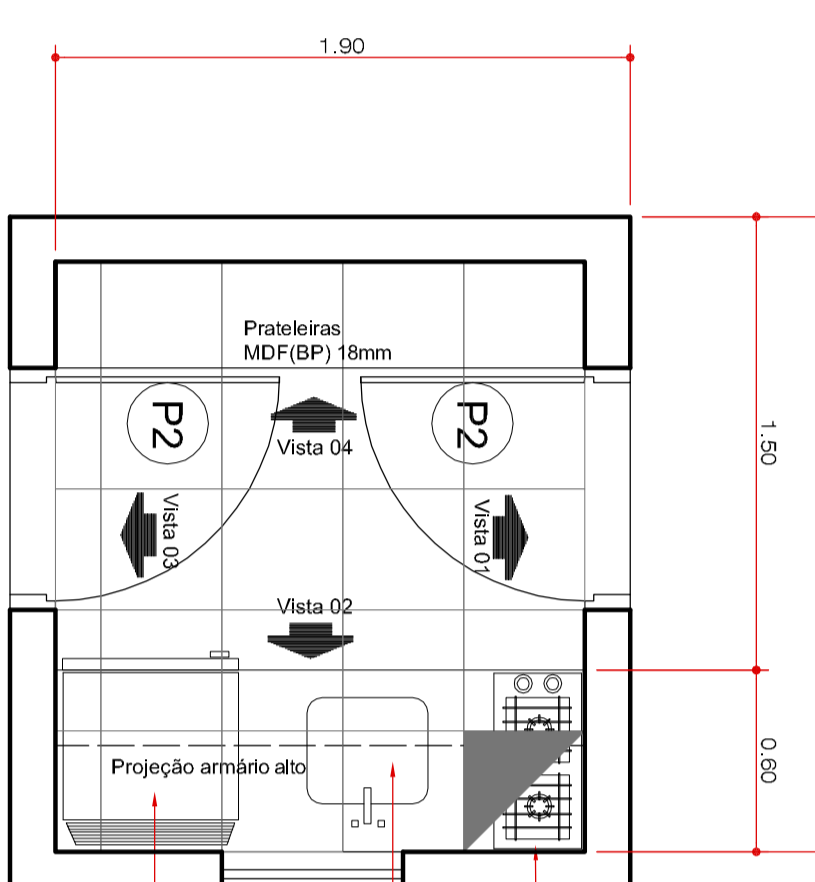

Detalhamento da copa

- 1 Alvenaria estrutural em bloco de concreto ou alvenaria 2x4"
- 2 Acost. Colarimetar. Alcatraz - espessura de 2cm e junta de 2cm no ar-grande
- 3 Paredes em alvenaria

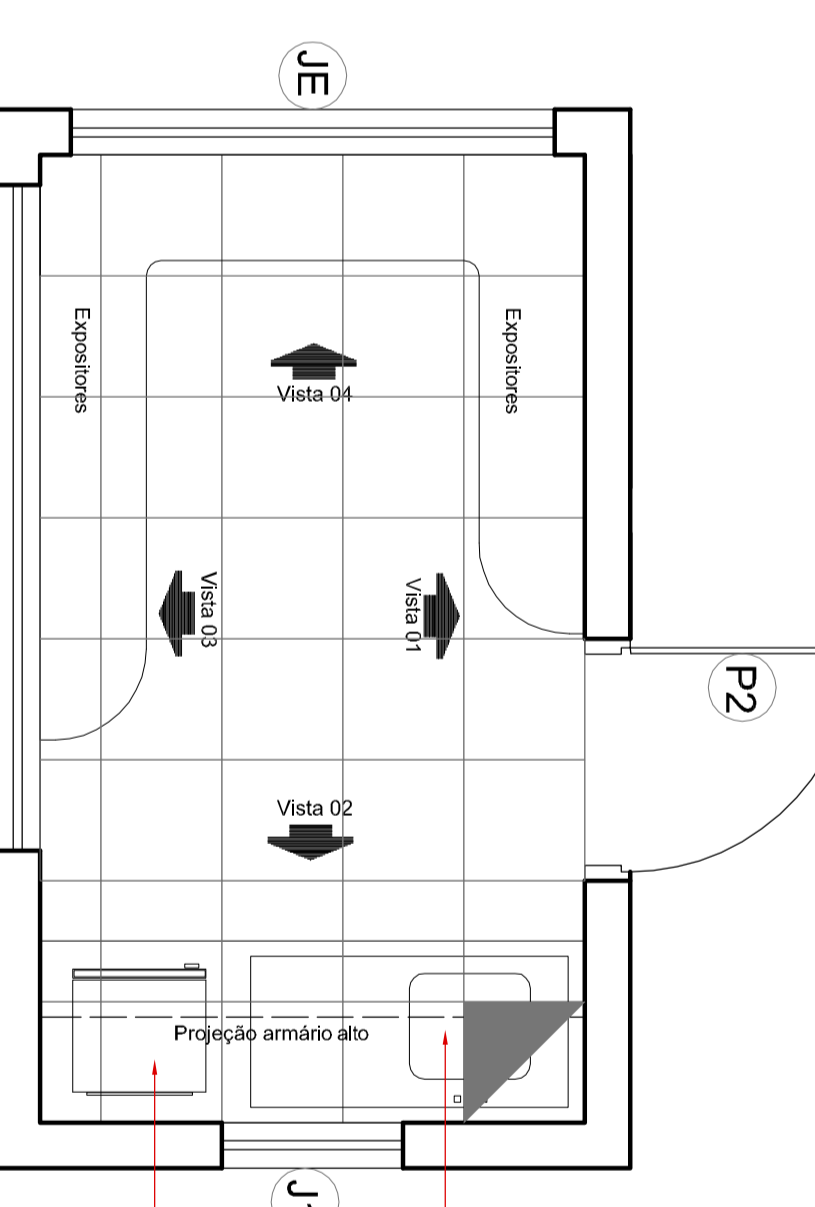

Detalhamento do atendimento

- 1 Alvenaria estrutural em bloco de concreto ou alvenaria 2x4"
- 2 Acost. Colarimetar. Alcatraz - espessura de 2cm e junta de 2cm no ar-grande
- 3 Paredes em alvenaria

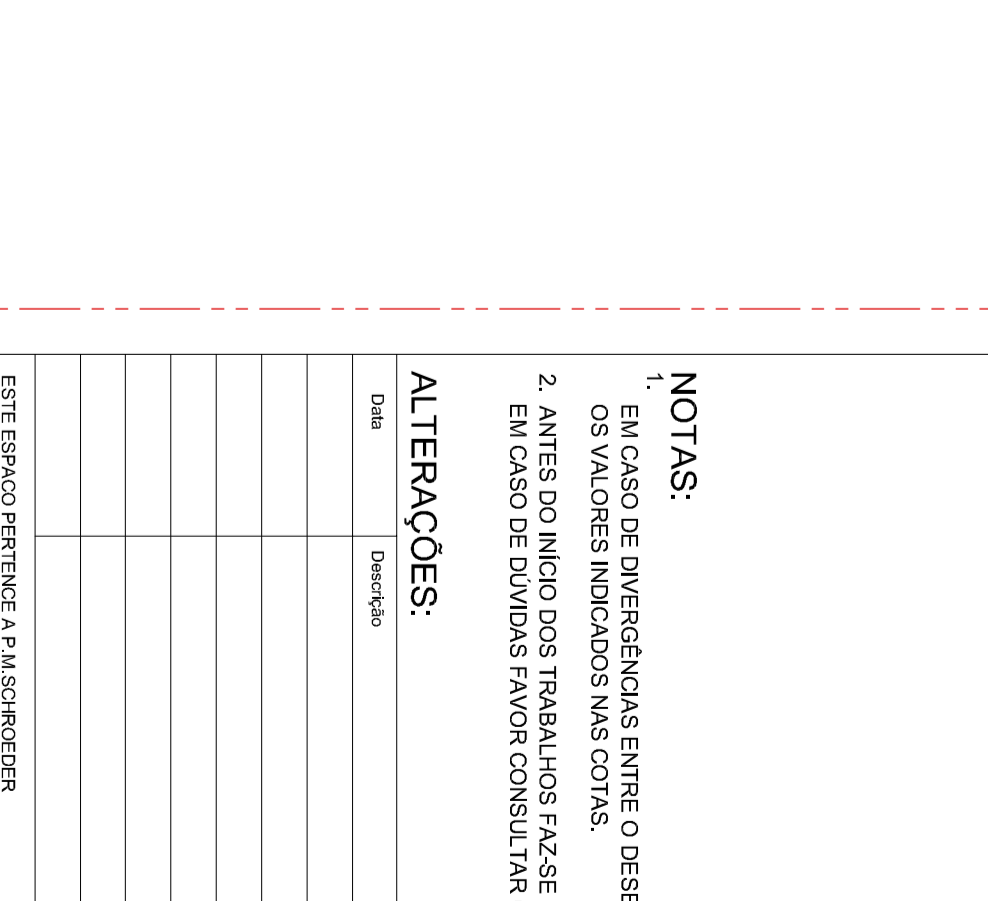
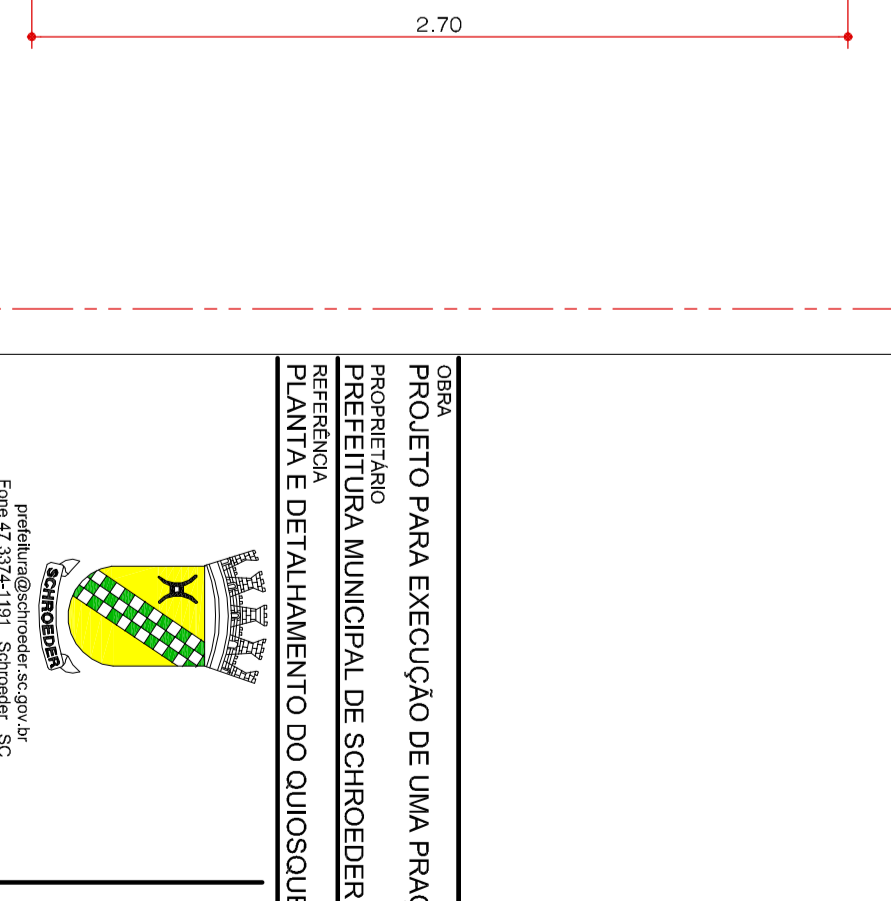
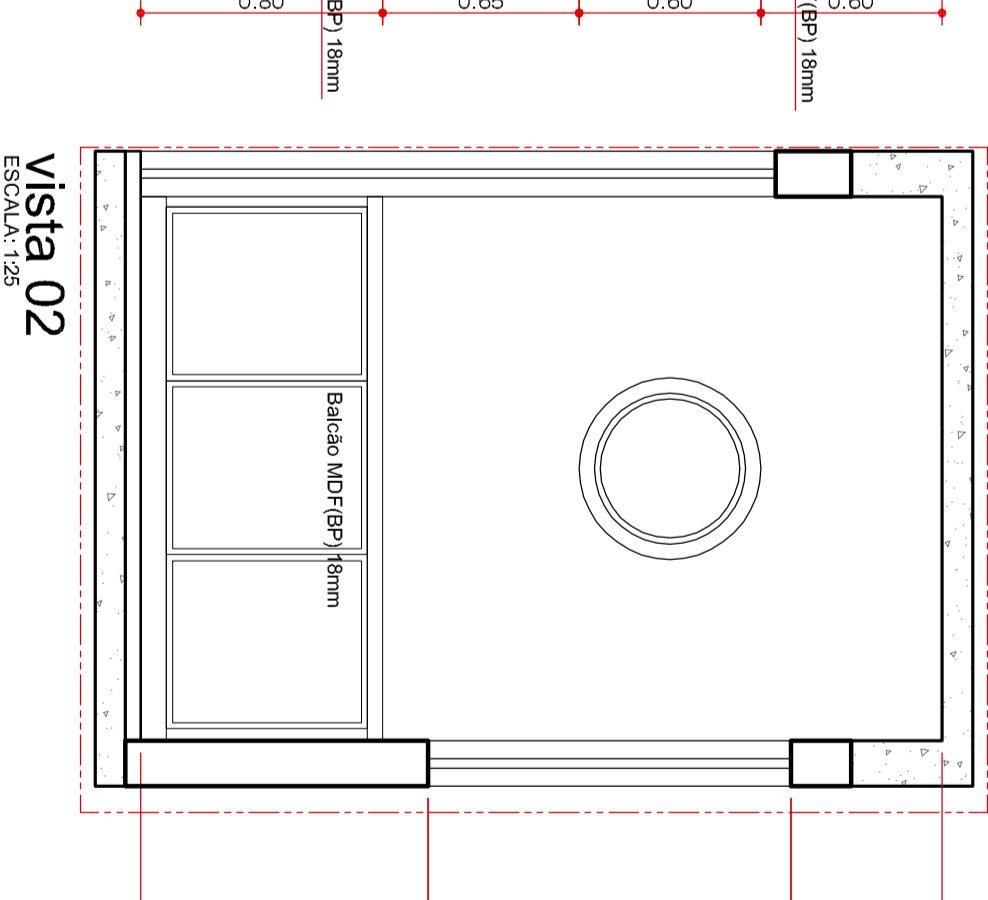
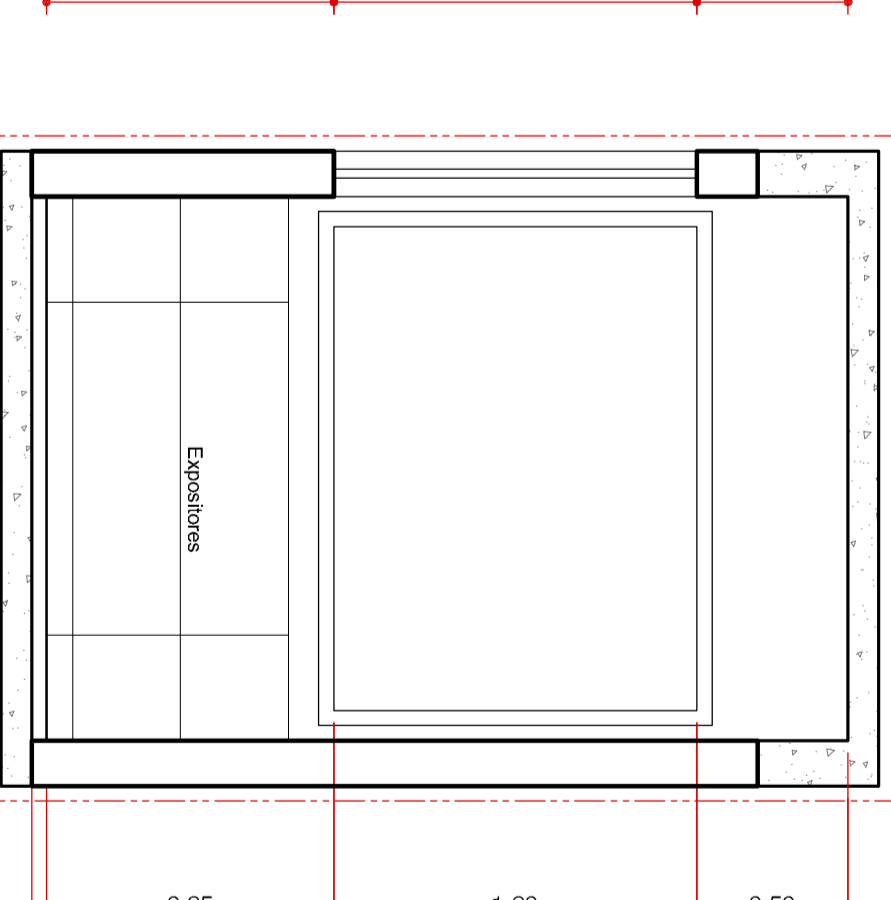
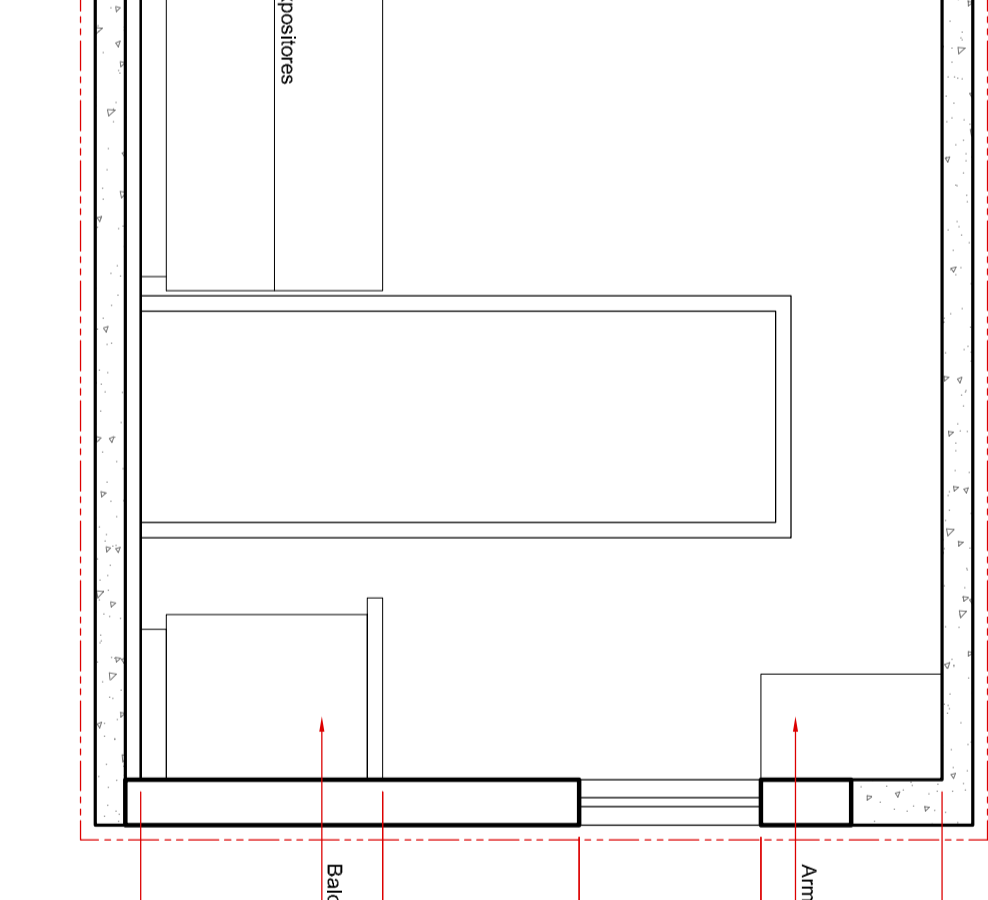
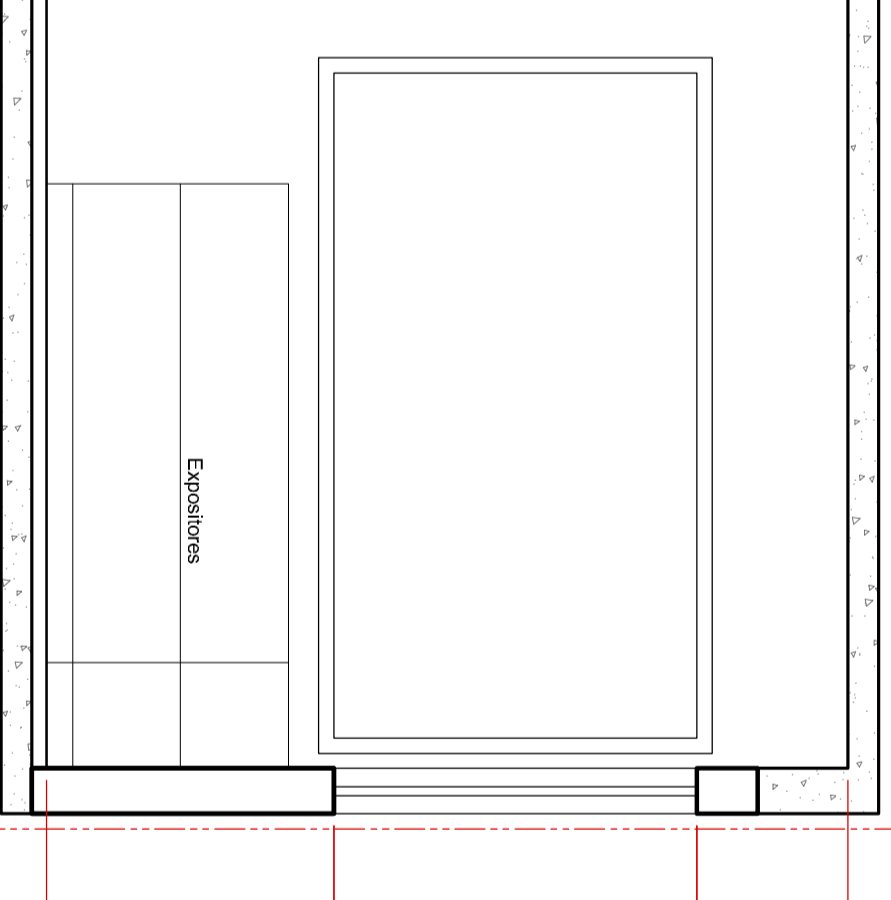
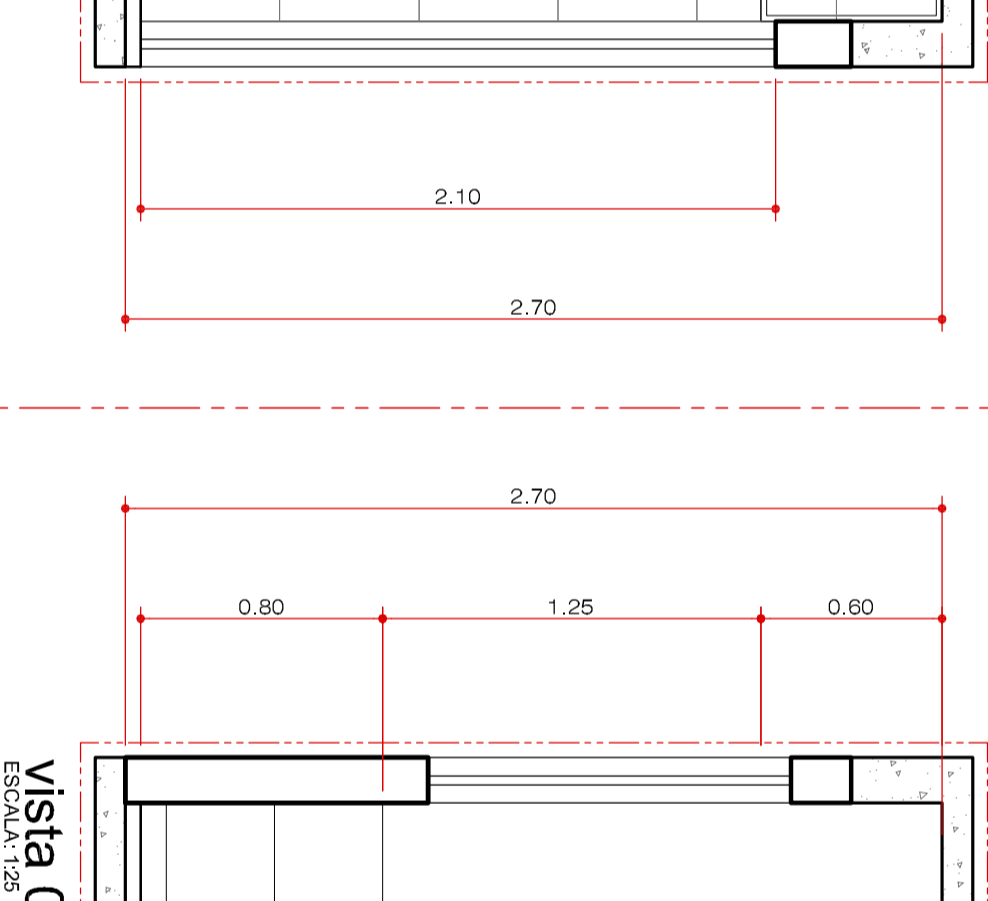
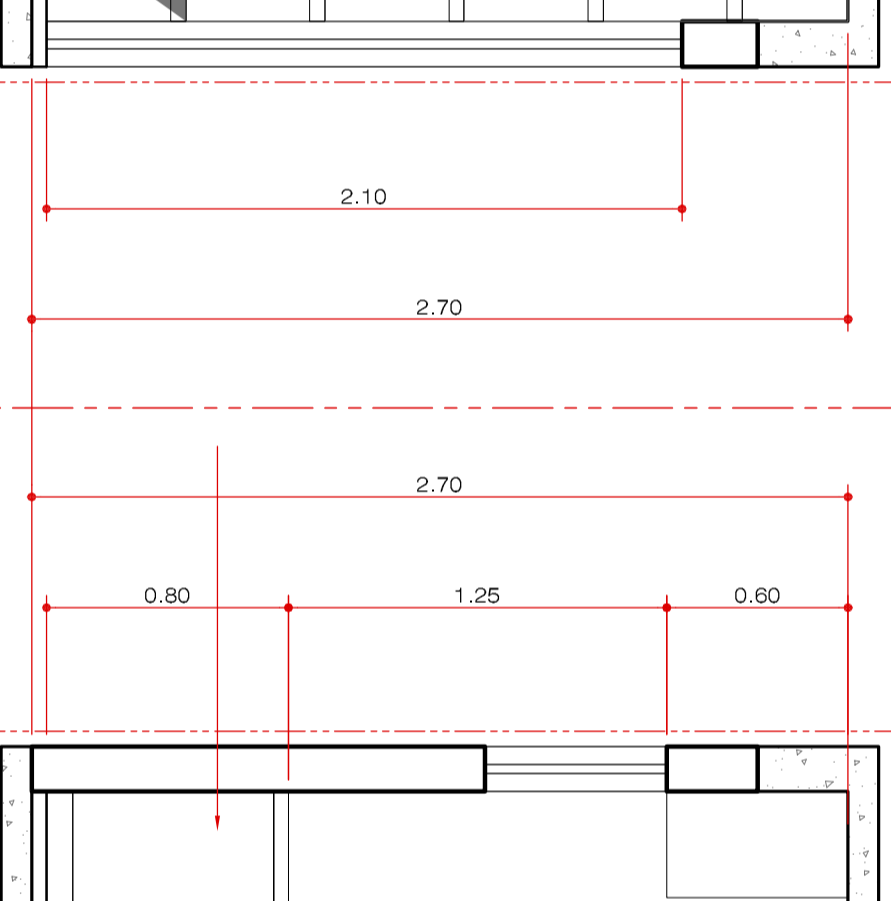
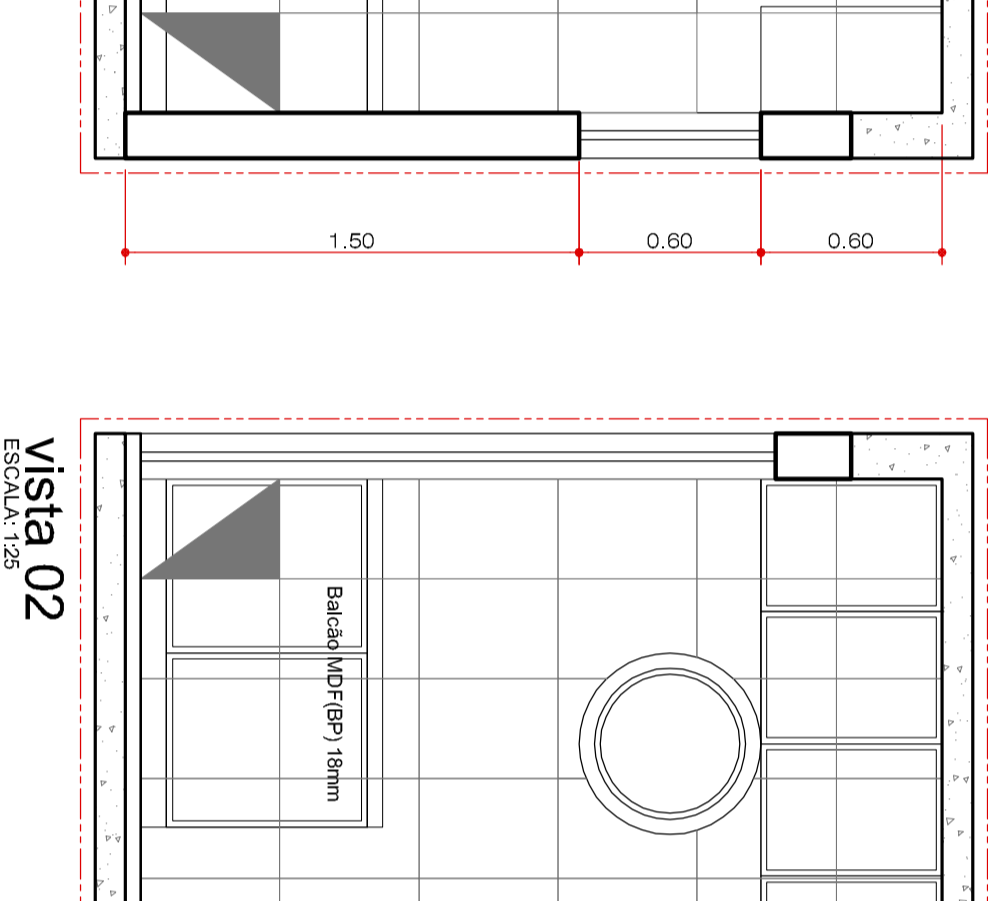
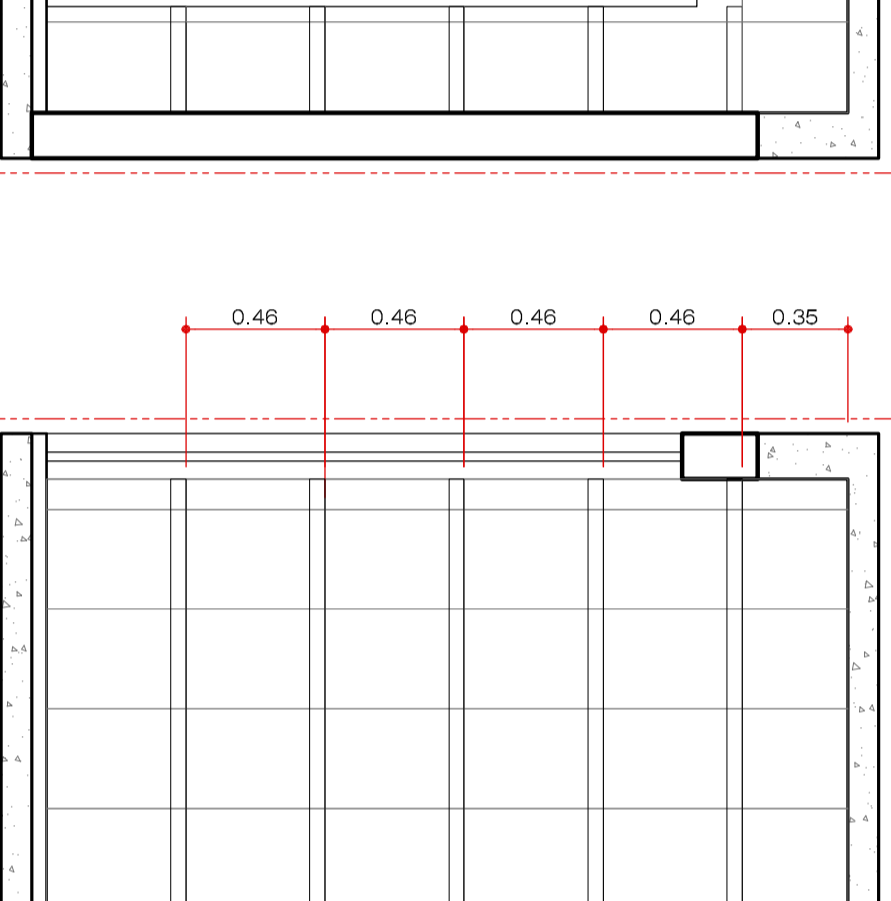
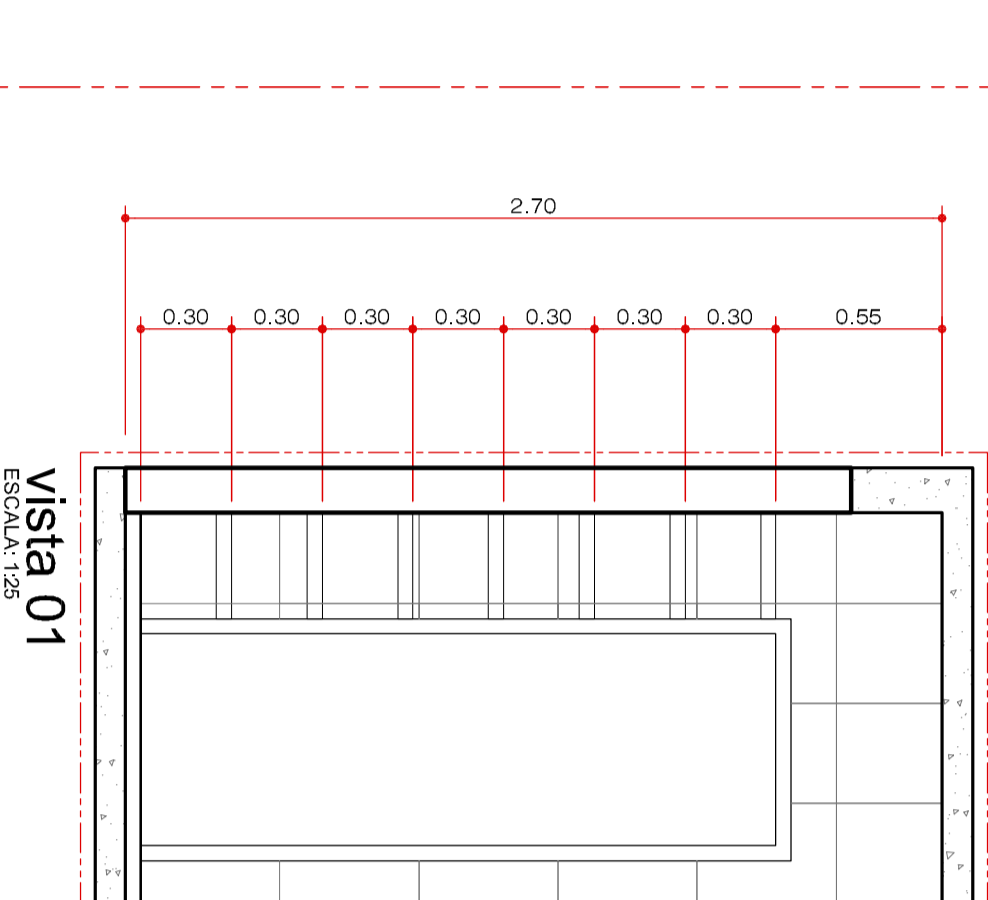
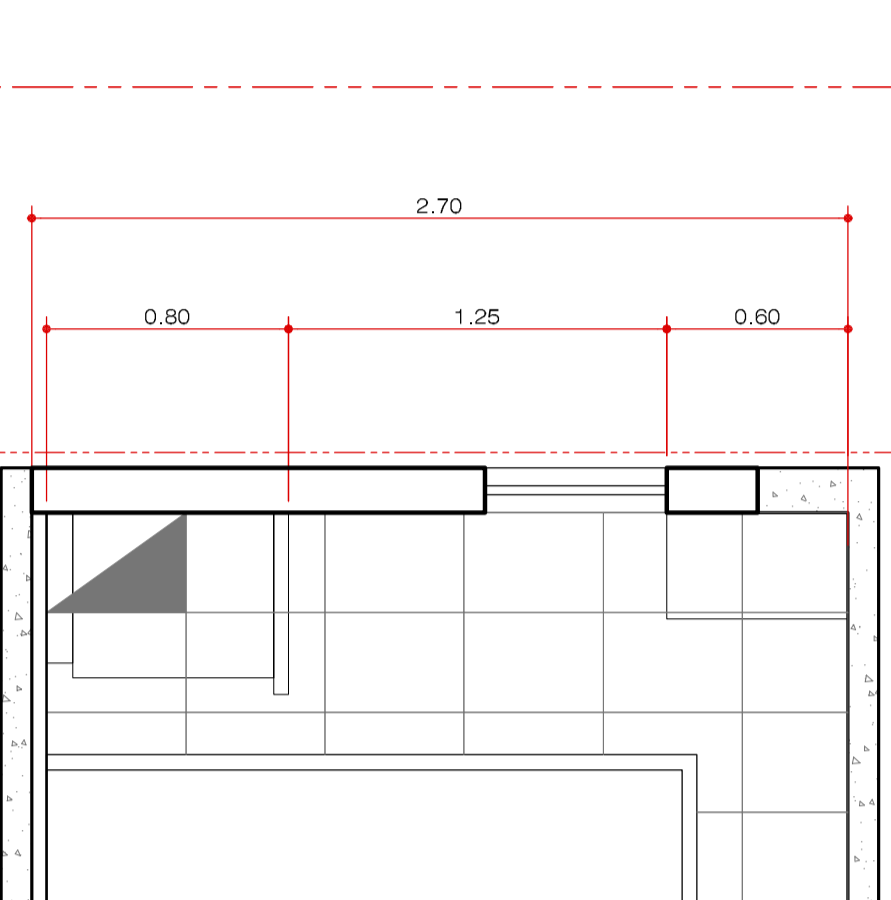
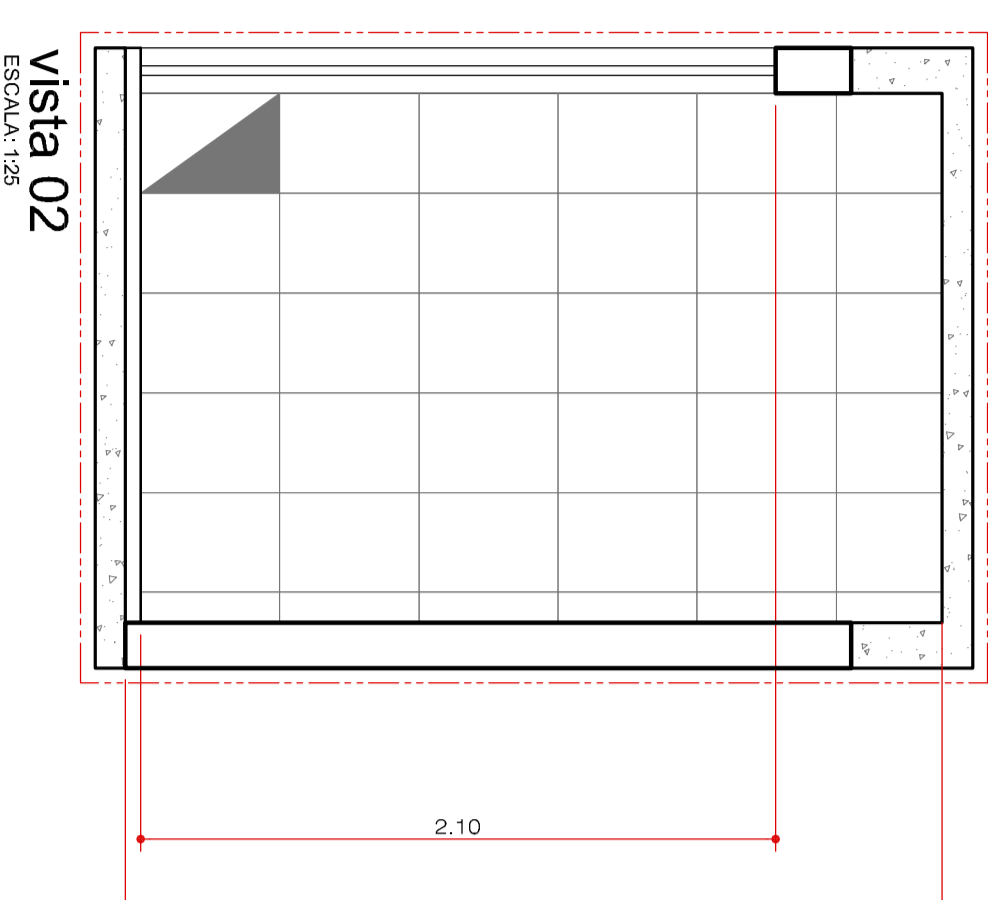
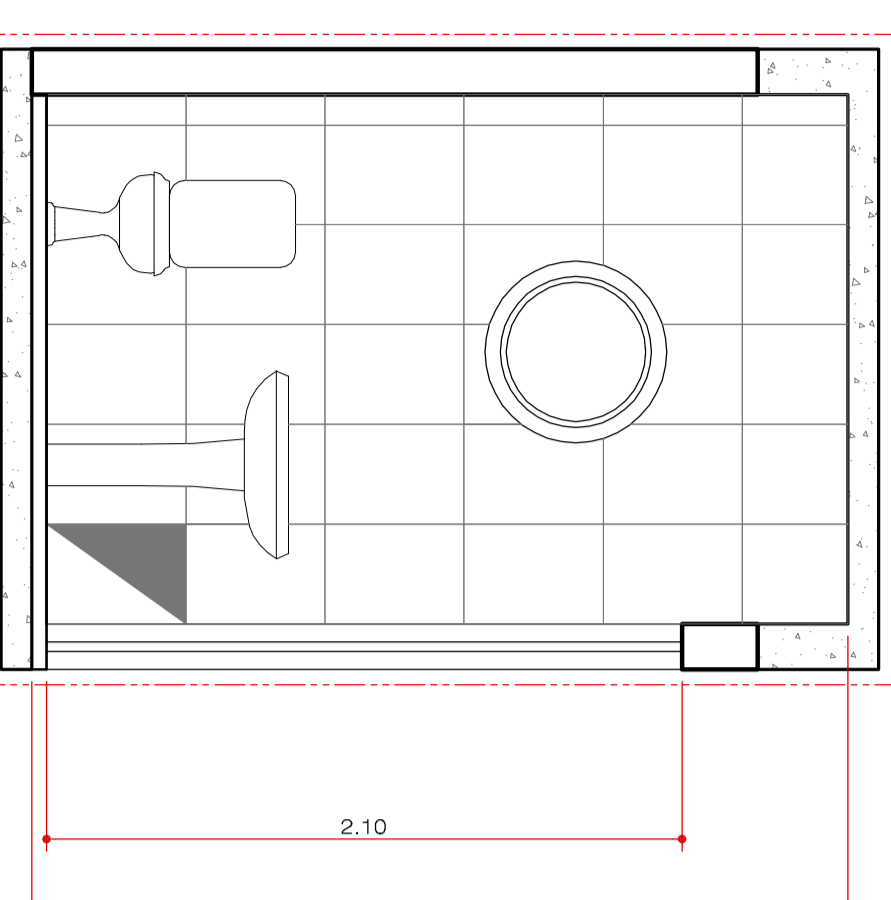
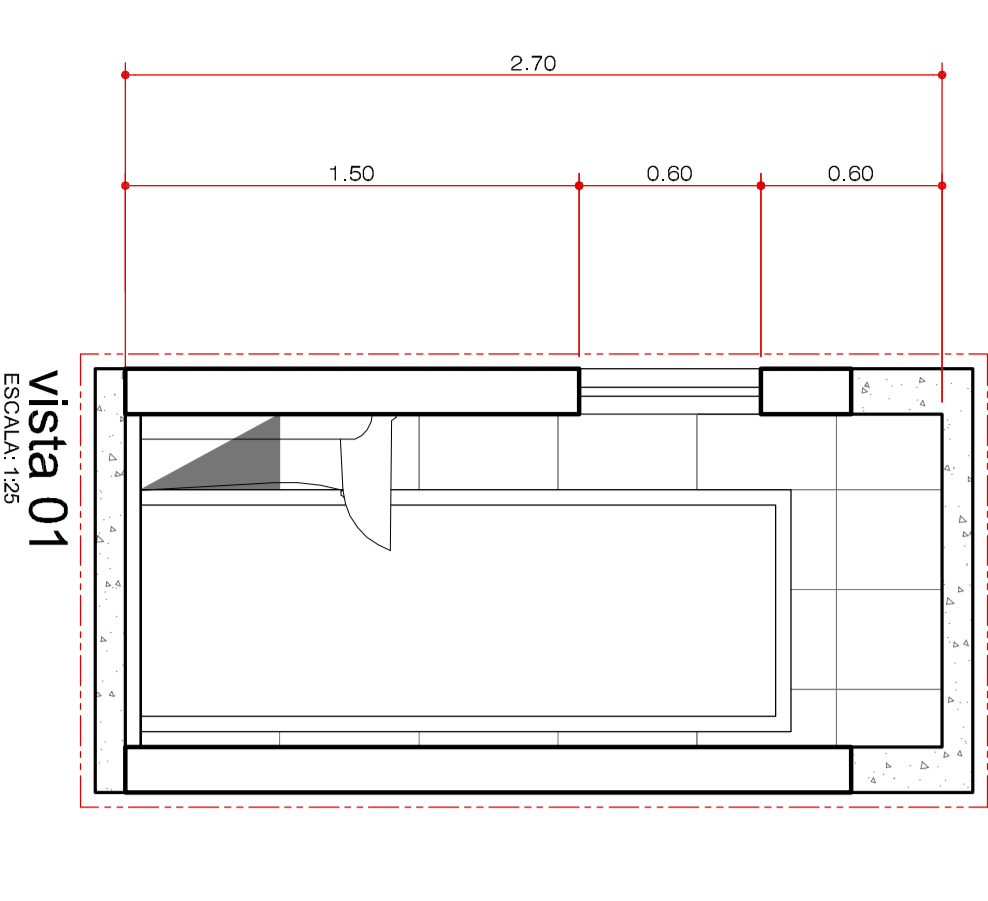
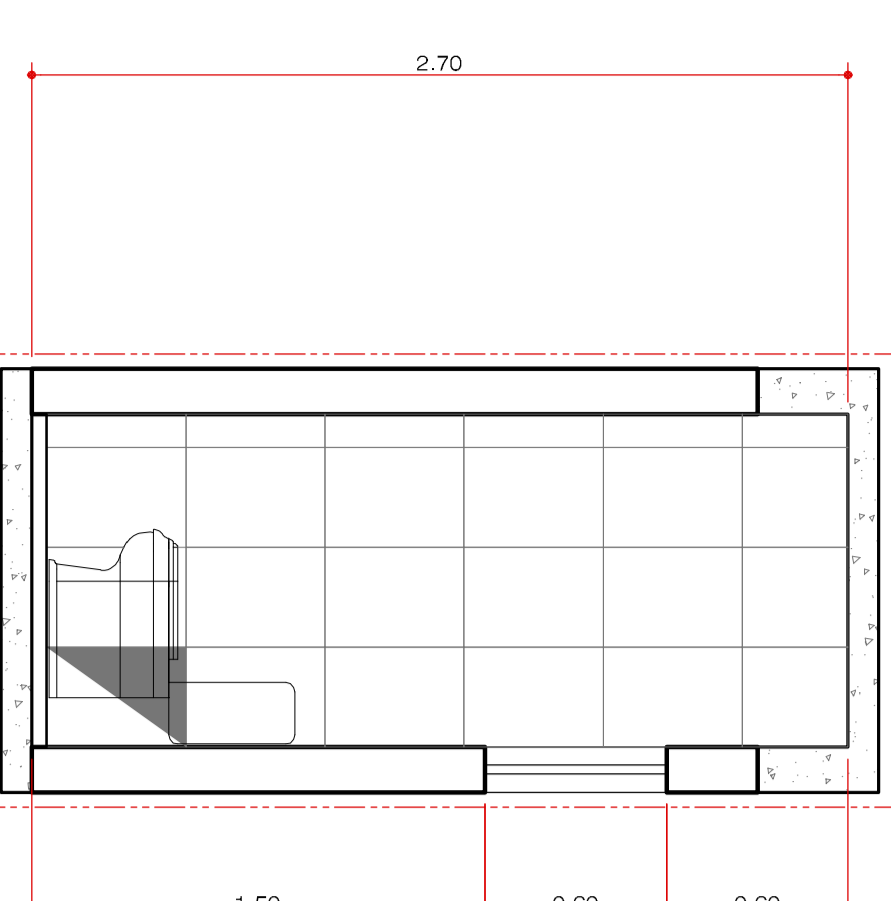

NOTAS:

1. EM CASO DE DIVERGENÇAS ENTRE O DESENHO E AS COTAS APRESENTADAS, PREVALECERÃO OS VALORES INDICADOS NAS COTAS.
2. ANTES DO INÍCIO DOS TRABALHOS FAZER NECESSÁRIO O PERMITO ENTENDIMENTO DO PROJETO.
3. EM CASO DE SERVIÇOS NÃO SOLICITADOS, NÃO SERÃO OBRIGATORIOS.

ALTERAÇÕES:

Data	Descrição	Colaborador

ESTE PROJETO PERTENCE A YASBECKER

PROJETO PARA EXECUÇÃO DE UMA PRAÇA NO MUNICÍPIO DE SCHROEDER-SC

INGA Engenharia e Arquitetura Ltda. São Carlos, SP

PA05